

Benötigtes Werkzeug:

Necessary tools:

Outil Nécessaire:

Nářadí potřebné pro montáž:

Potrzebne narzędzia:

Potrebné náradie:

Szükséges szerszámok:

Herramientas necesarias:

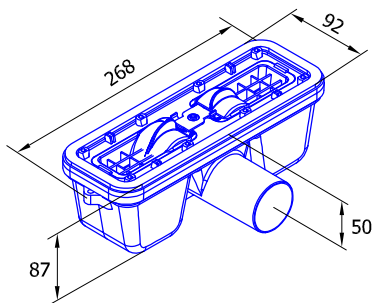
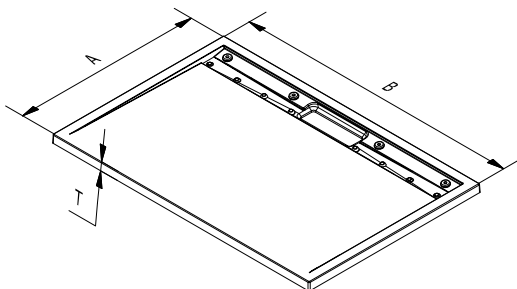
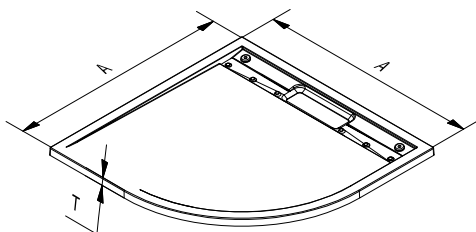
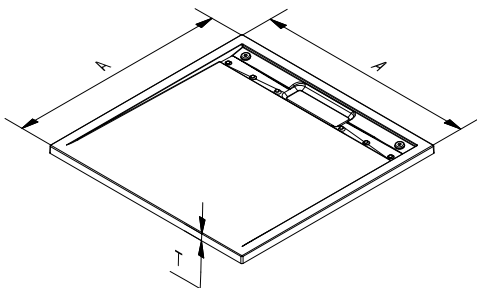
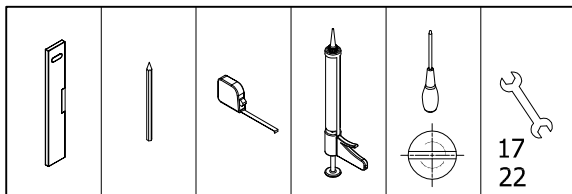

A

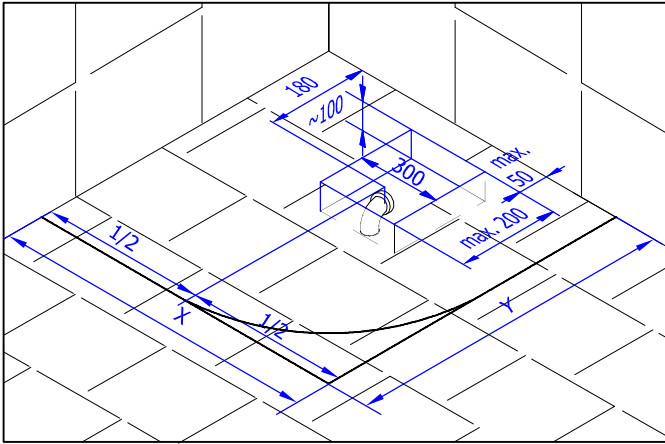

OK

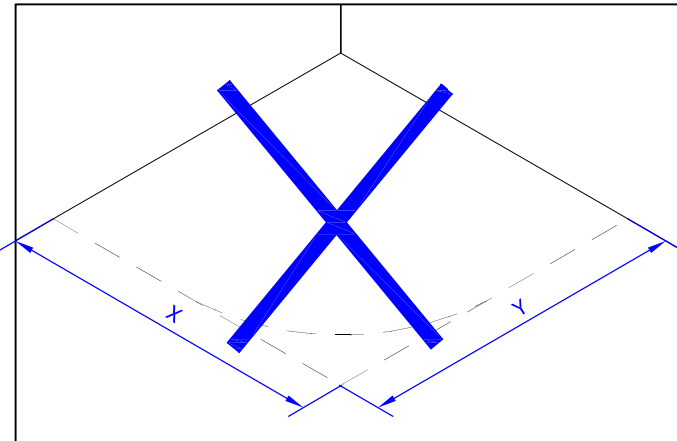
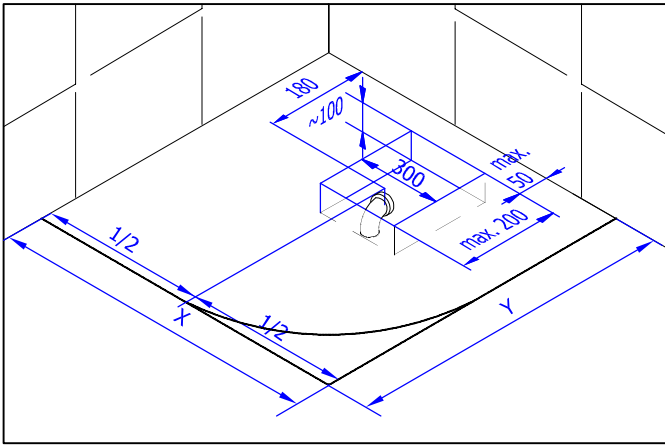

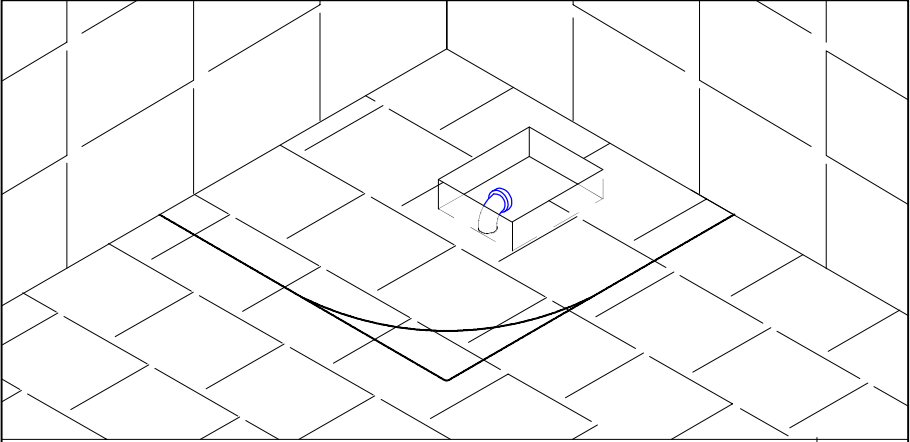

DN 50

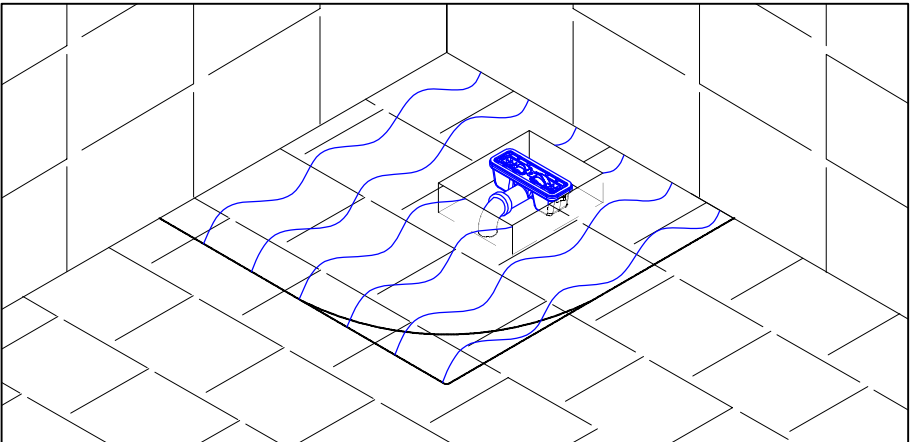
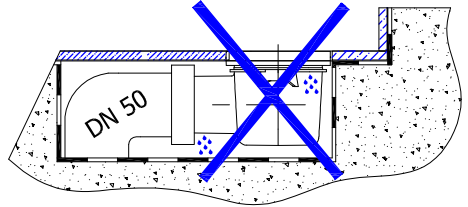
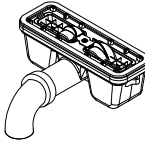
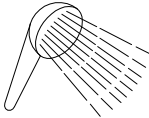
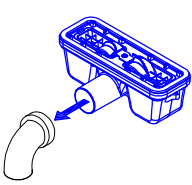
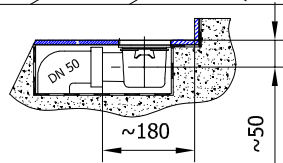
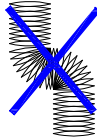

ADHESIVE/SILICONE

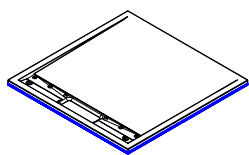

4,5 x 16 mm

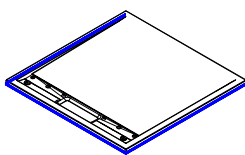

4,5 x 16 mm

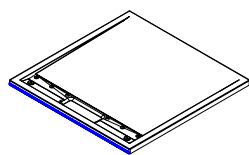

4,5 x 16 mm

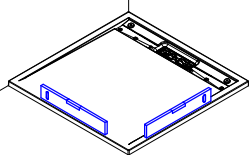
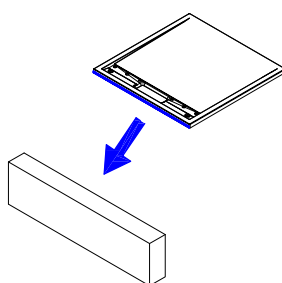
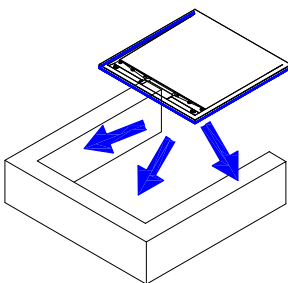
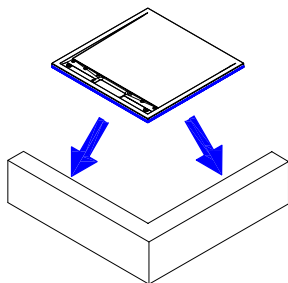

!  max 0.5 mm !

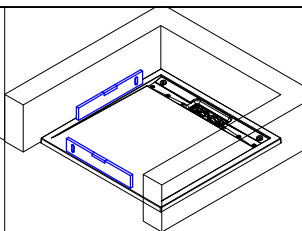

!  max 0.5 mm !

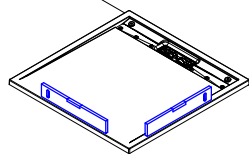

!  max 0.5 mm !

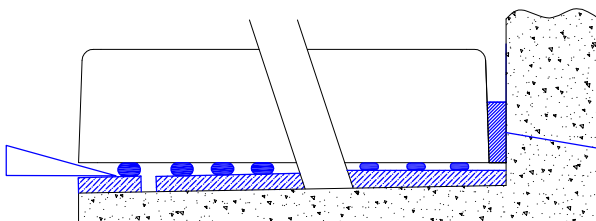

4,5 x 16 mm (3 m)



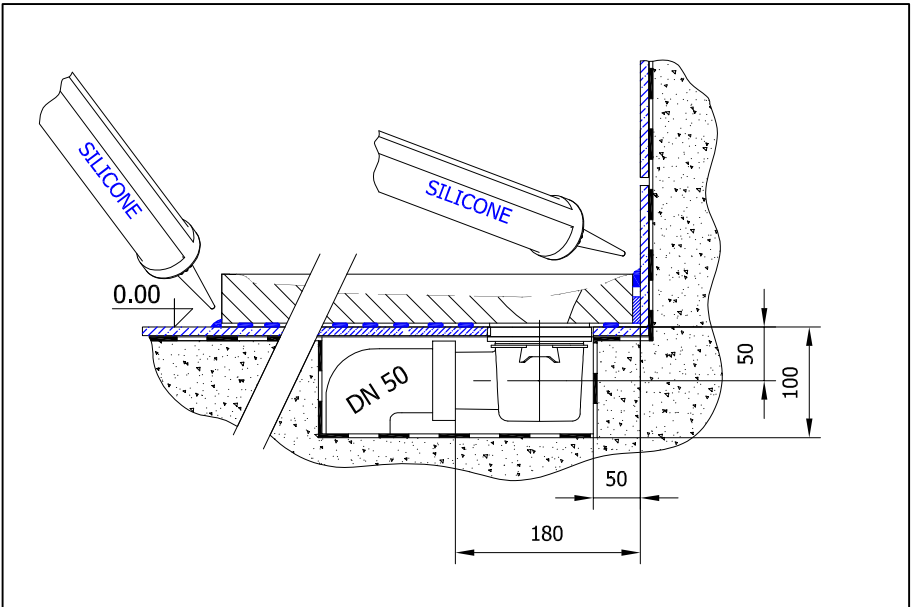
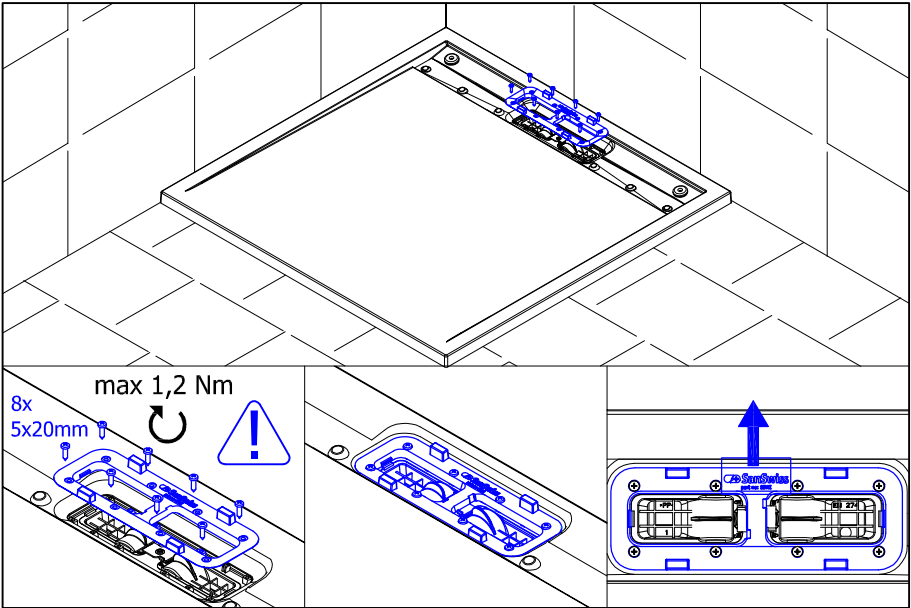

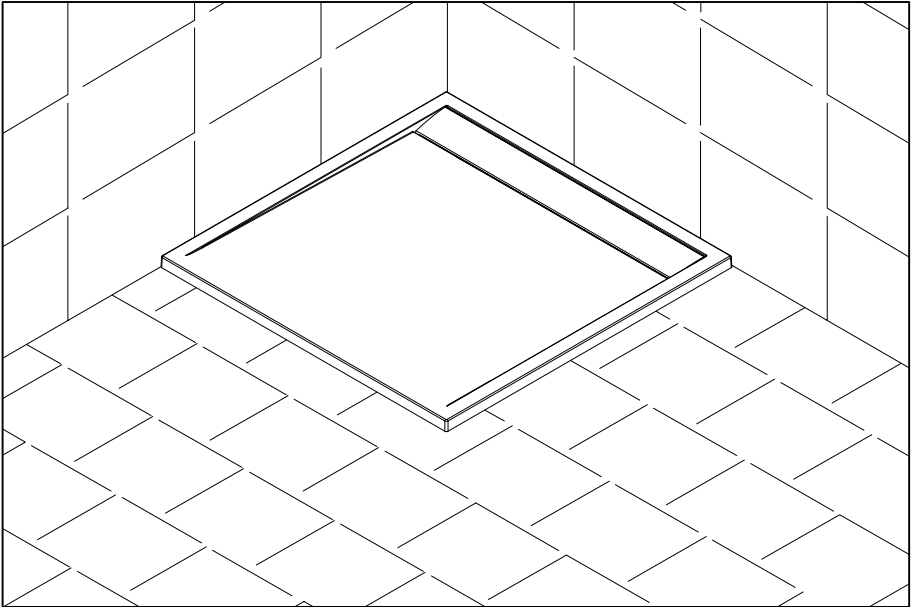
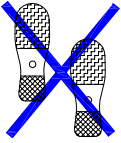
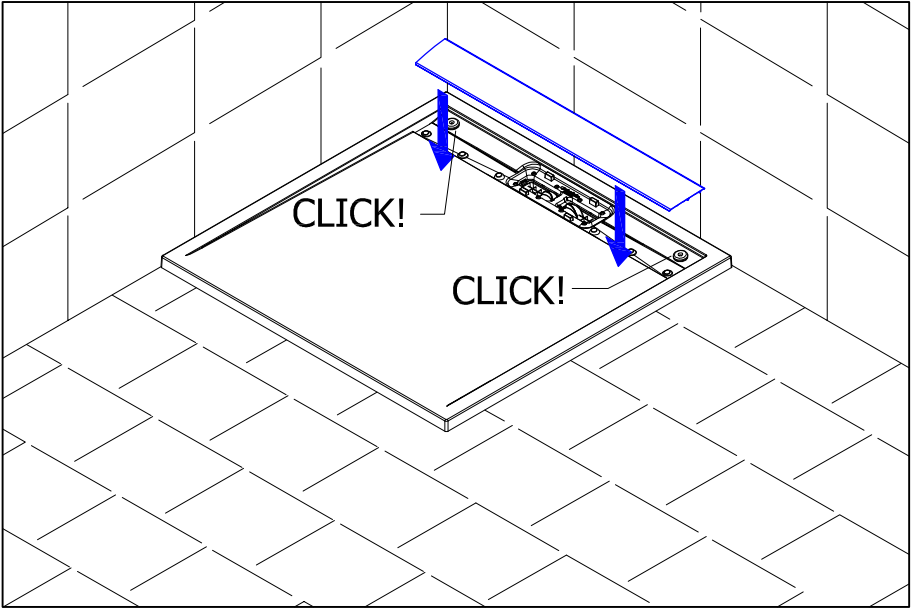

B+C

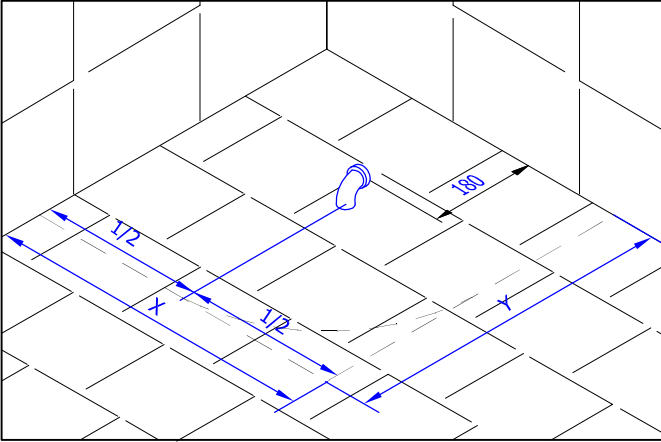

OK

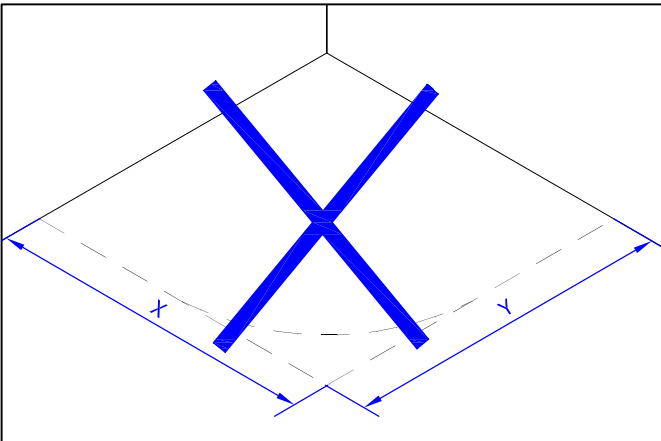
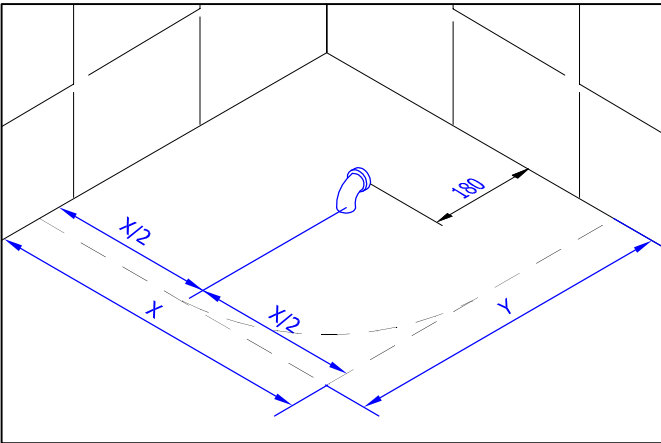

B+C

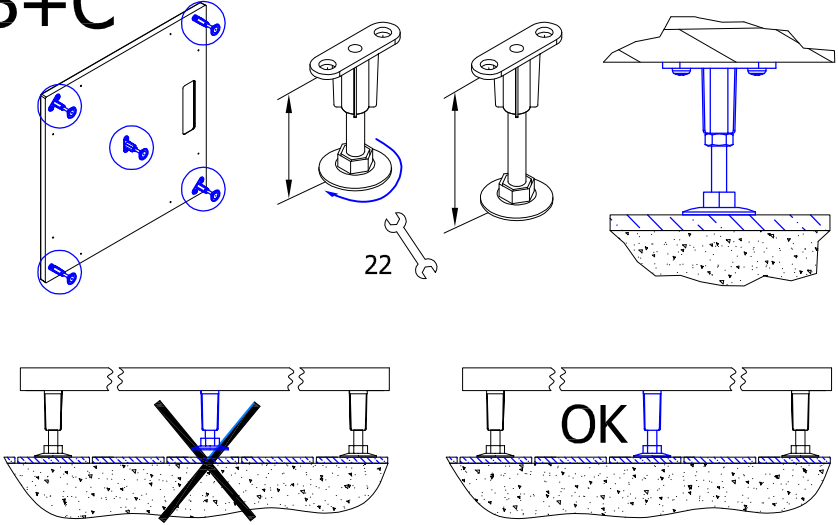

DN 50

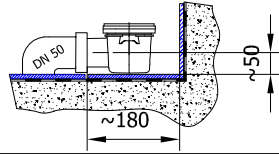
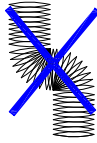

C

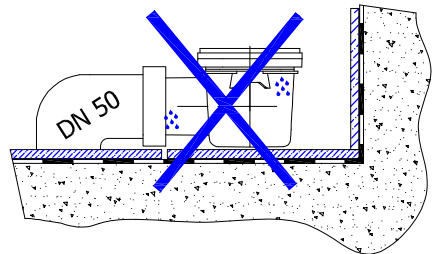
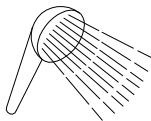
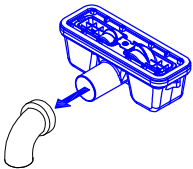
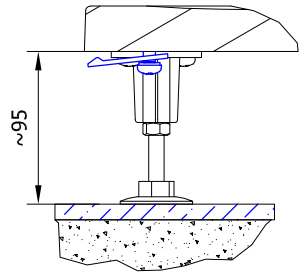
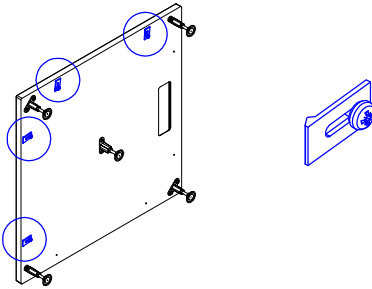

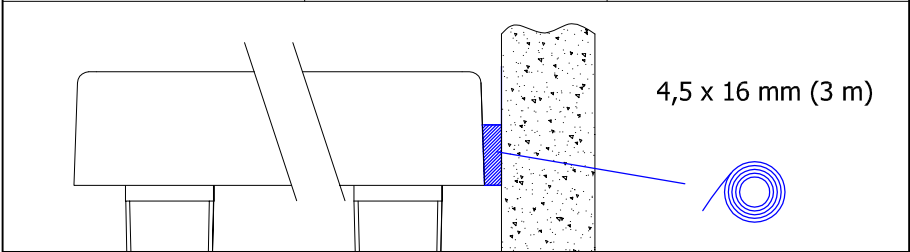
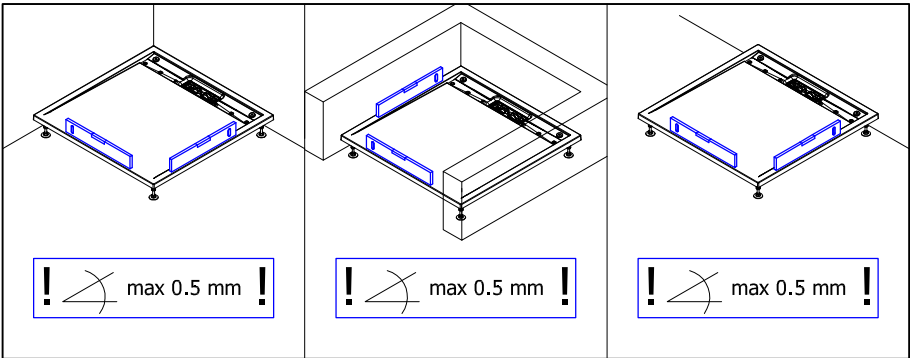
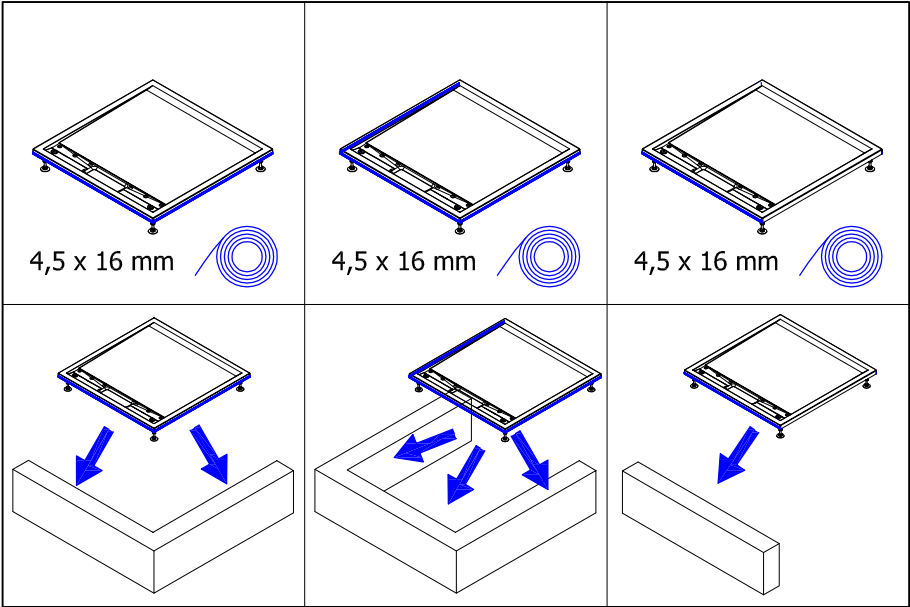

B

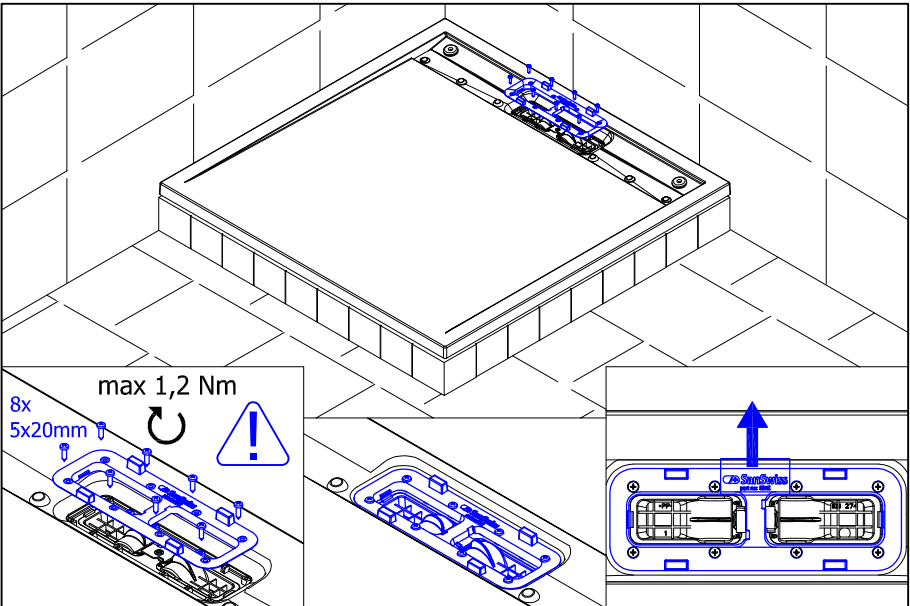
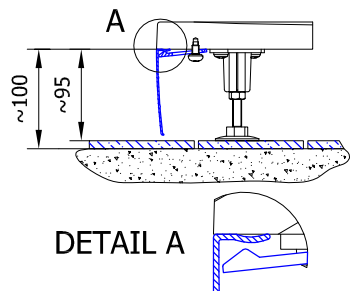
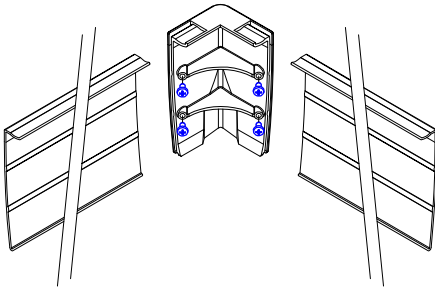
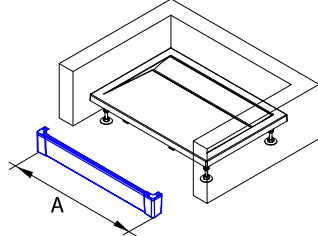
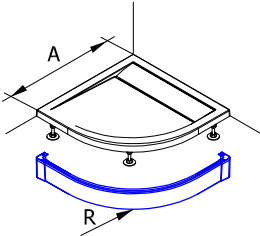
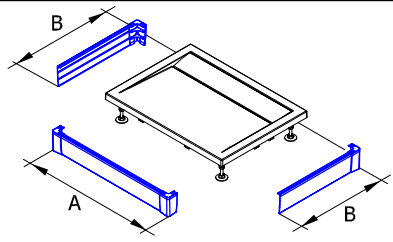
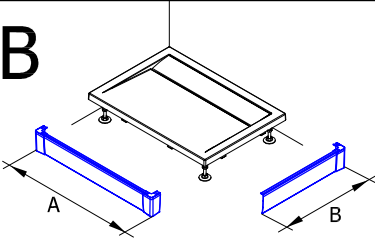

max 1,2 Nm

8x
5x20mm



28 SunOptics

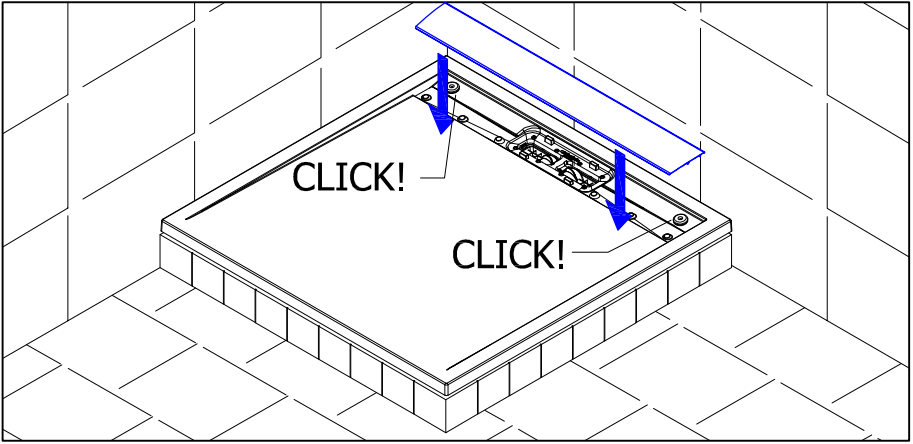

B+C

