

19308

| | | |
|------|----------------------------|--|
| (D) | MONTAGEANLEITUNG: | PENDELTÜR, 2-TEILIG + SEITENWAND FÜR SECK |
| (GB) | INSTALLATION INSTRUCTIONS: | DOOR WITH 2 PIVOT PANELS + FIXED PANEL PENTAGONAL |
| (F) | NOTICE DE MONTAGE: | PORTE SALOON + PAROI FIXE PENTAGONAL |
| (CZ) | NÁVOD K MONTÁŽI: | DVOUKŘÍDLÉ DVEŘE + BOČNÍ STĚNA PRO PĚTIÚHELNÍK |
| (PL) | INSTRUKCJA MONTAŻU: | 2-CZĘŚCIOWE DRZWI WAHAND ŁOWE + ŚCIANKA BOCZNA DLA PIĘCIOKĄT |
| (SK) | NÁVOD NA MONTÁŽ: | DVOJKRÍDLOVÉ DVEŘE + BOČNÁ STĚNA PRE PÄTUHOLNÍK |
| (RU) | ИНСТРУКЦИЯ ПО МОНТАЖУ | ДВУХСТВОРЧАТАЯ ДВЕРЬ + ФИКСИРОВАННАЯ ПАНЕЛЬ / ДВУХСТВОРЧАТАЯ ДВЕРЬ |
| (E) | INSTRUCCIONES DE MONTAJE: | PUERTA PIVOTANTE, 2 PIEZAS + LATERAL PENTAGONAL |
| (RO) | INSTRUCȚIUNI DE MONTAJ: | UȘĂ BATANTĂ, 2 PIESE + LATERAL PENTAGONAL |

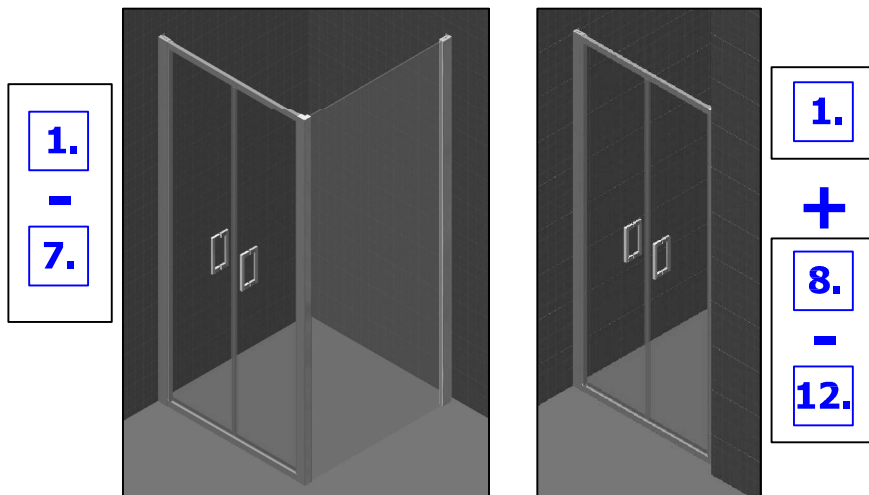

Benötigtes Werkzeug:

Necessary tools:

Outil Nécessaire:

Nářadí potřebné pro montáž:

Potrzebne narzēdzia:

Potrēbnē nārādīe:

необходимые инструменты :

Herramientas necesarias:



1x

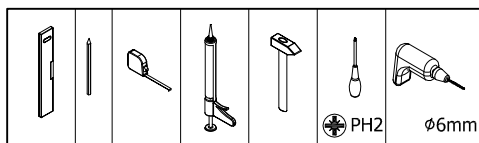

PH2

∅6mm

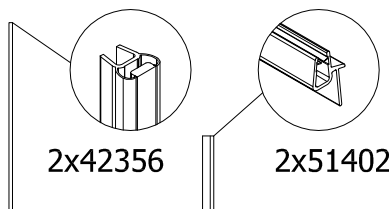
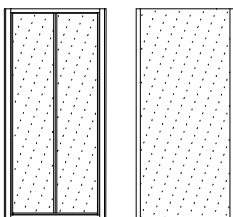

2x42356

2x51402

- DE VERSTELLBEREICH FÜR MONTAGE AUF DUSCHWANNE ODER BODENEbenen.
- GB PRESETTING RANGE FOR ASSAMBLAGE ON THE SHOWER TRAY OR ON THE PAVAGE.
- F PLAGE DE RÉGLAGE POUR UNE POSE SUR RECEVEUR OU À L'ITALIENNE.
- CZ PŘESTAVNÁ MÍRY PRO MONTÁŽ NA VANIČKU NEBO NA DLAŽBU.
- PL ZAKRES REGULACJI DO MONTAŻU NA BRODZIKU LUB BEZPOŚREDNIO NA POSADZCE.
- SK PRESTAVNÁ ŠÍRKA PRE MONTÁŽ NA VANIČKU ALEBO PODLAHU.
- RU РЕГУЛИРОВКА ШИРИНЫ ДЛЯ УСТАНОВКИ НА ДУШЕВОЙ ПОДДОН ИЛИ НА ПОЛ .
- E ZONA DE AJUSTE EN PLATOS DE DUCHA O A RAS DE SUELO.

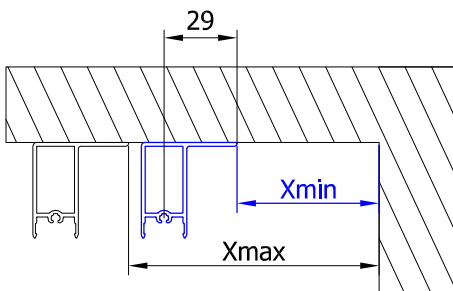
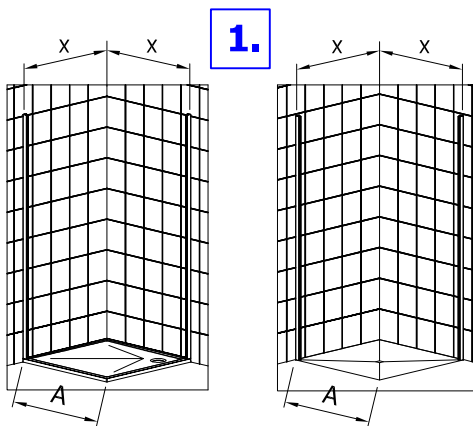

| A | Xmin | Xmax |
|------|------|------|
| 800 | 734 | 759 |
| 900 | 834 | 859 |
| 1000 | 934 | 959 |



Zubehör:
 Equipment:
 Accessoires:
 Příslušenství:
 Dodatki:
 Príslušenstvo:
 Аксессуары:
 Accesorios:

| | | | | | |
|-----------|-----------|---------------|-----------------------|-------------------------|--------------------|
| | | | | | |
| | 1 x 11221 | 6x81254 | 6 x 14295 4 x 32mm | 2 x 14196 3,5 x 13mm | 6 x 16000 ø 6mm |
| | | | | | |
| 2 x 81330 | 2 x 81230 | 2 x MT8010.10 | | | |

| | | |
|--|---------|---------|
| | | |
| | 1x81457 | 1x81458 |

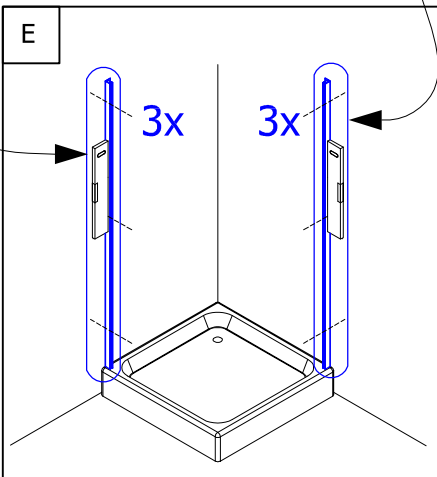
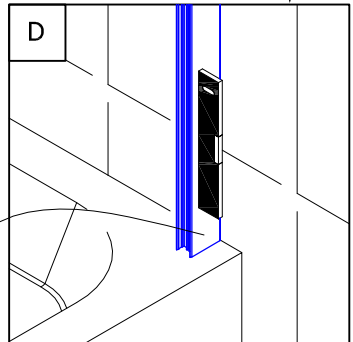
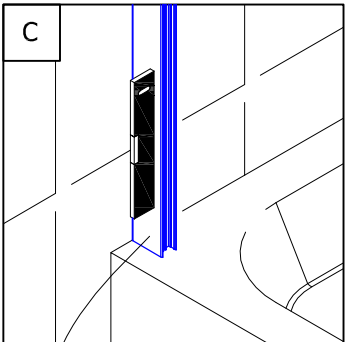
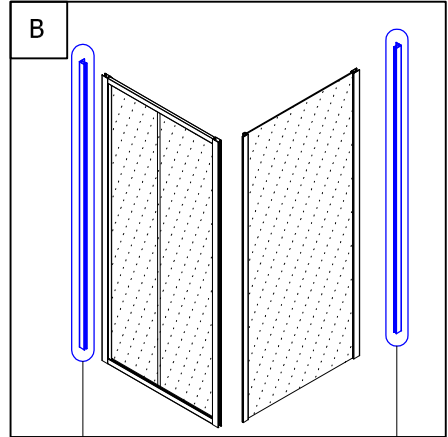
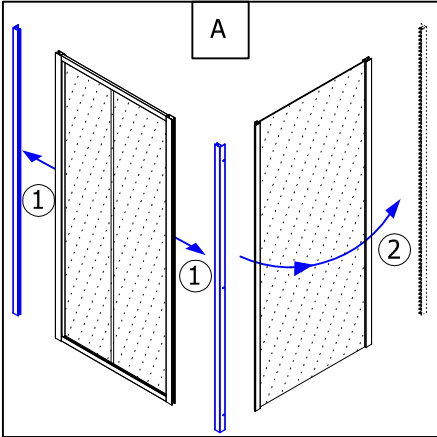
2.

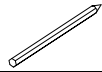
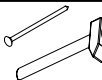

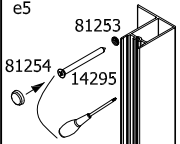
- e1 
- e2 
- e3 
- e4  16000
- e5  81253
81254 14295

3.

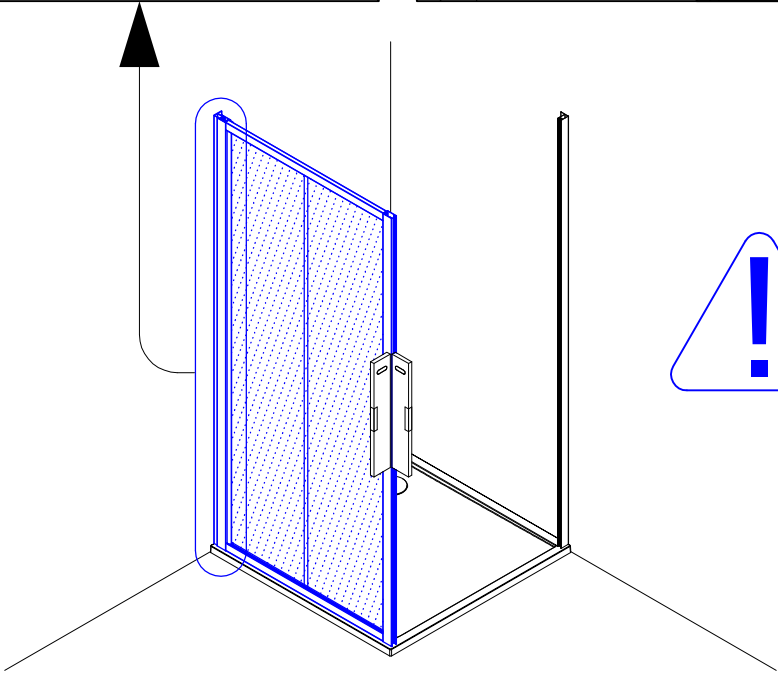
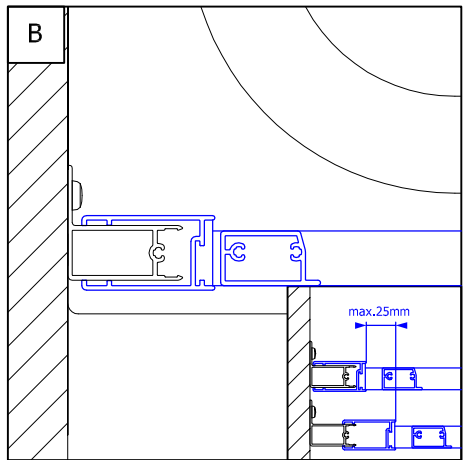
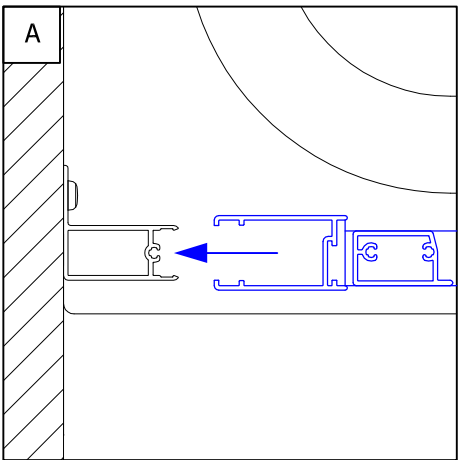
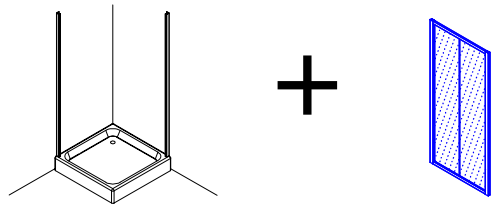

4.

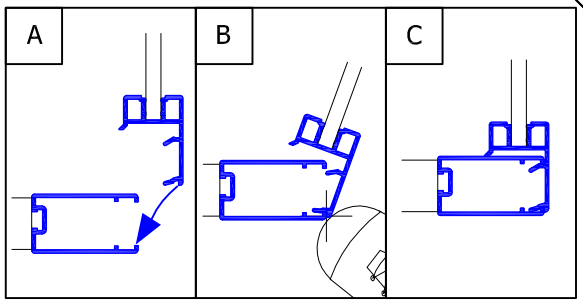
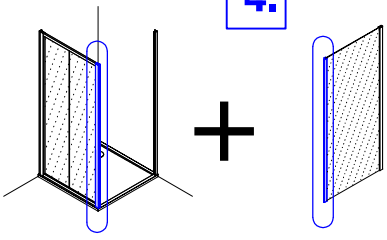

5.

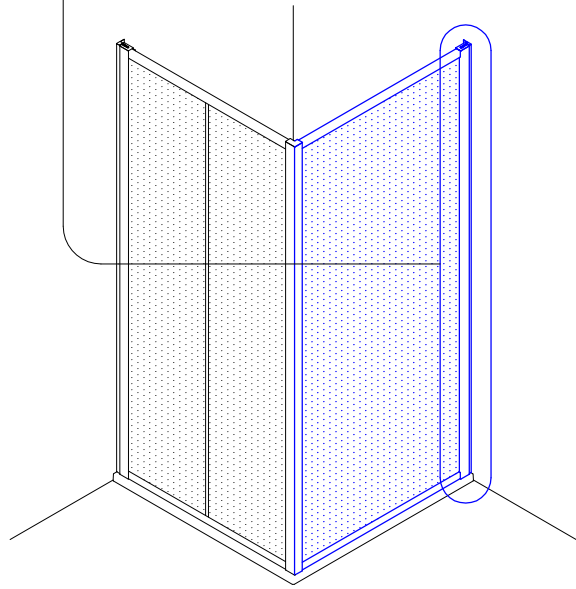
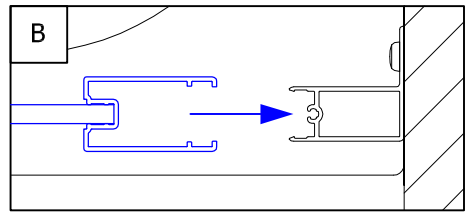
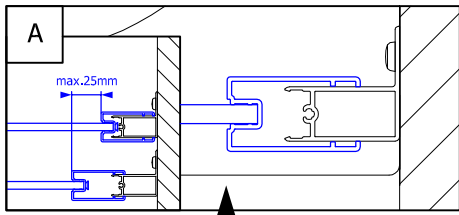
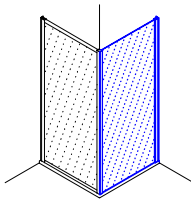

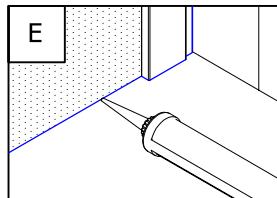
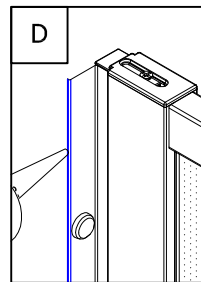
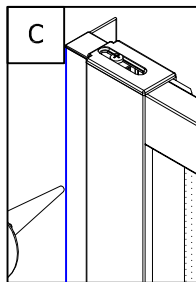
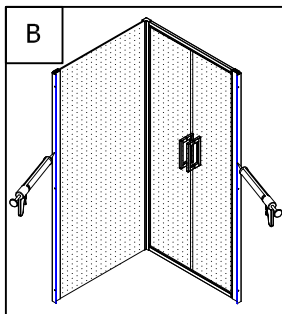
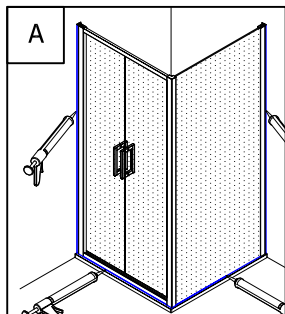
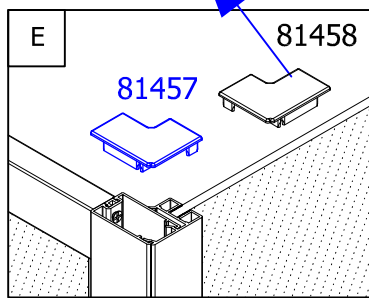
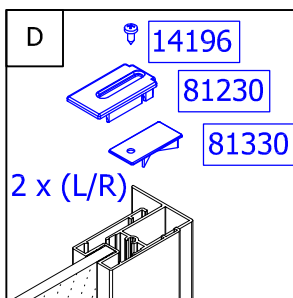
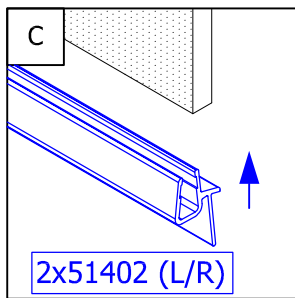
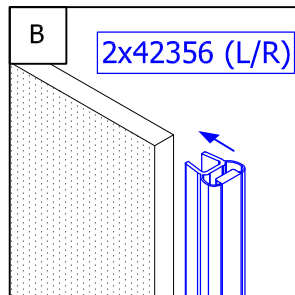
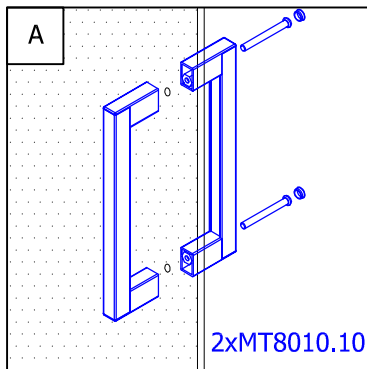
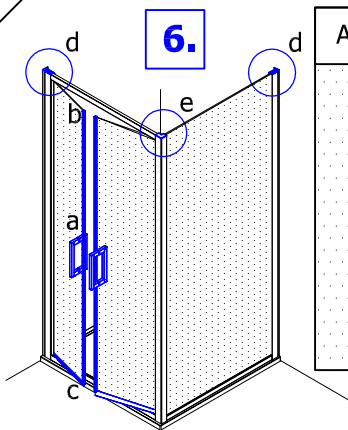

Achtung! Nur Sanitär-Silikon - bakterizid und fungizid eingestellt verwenden.

Caution! Use only bactericidal and fungicidal sanitary silicone.

Attention! N'utiliser que du silicone sanitaire bactéricide et fongicide.

Pozor! Používejte pouze baktericidní a fungicidní sanitární silikon.

Uwaga! Stosować tylko silikon sanitarny - bakterio i grzybobójczy.

Pozor! Užívajte pouze baktericidný a fungicidný sanitárny silikon.

Внимание! Применяйте только антибактериальные силиконовые герметики с фунгицидом

Cuidado! Utilizar solamente silicona sanitaria bactericida y fungicida.

7.

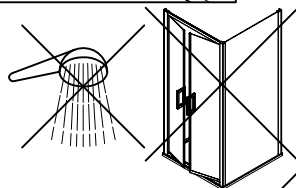

8.

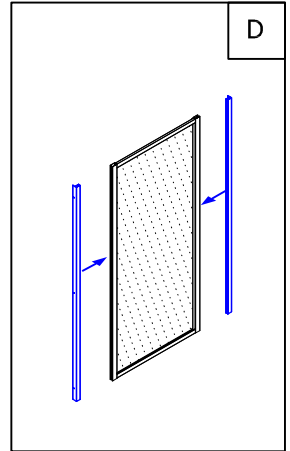
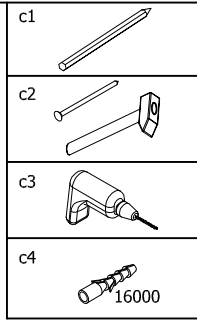
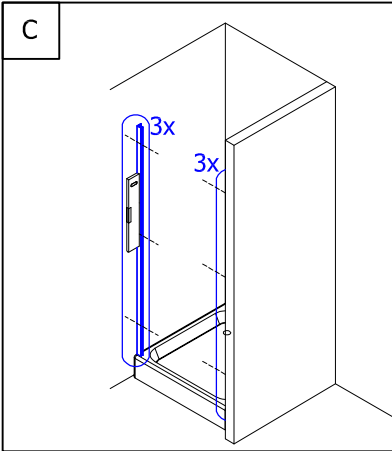
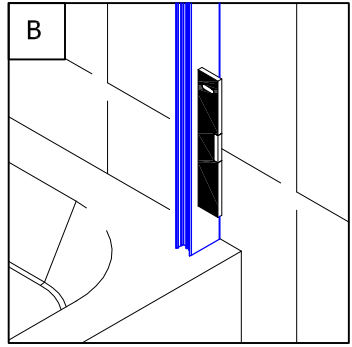
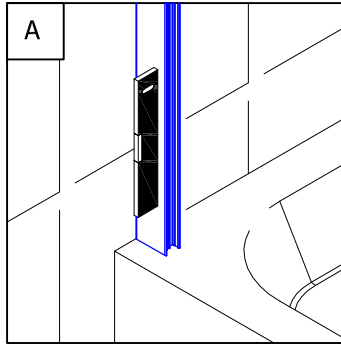
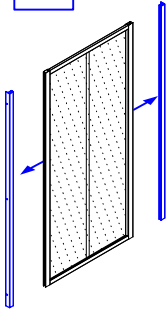

9.

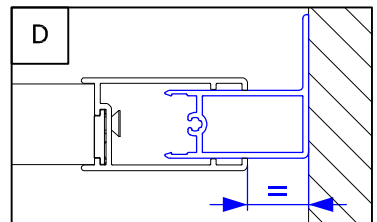
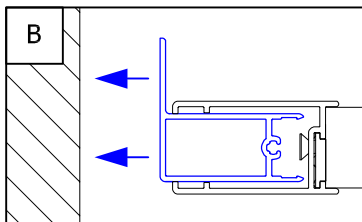
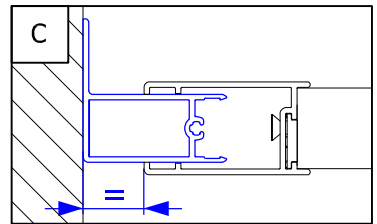
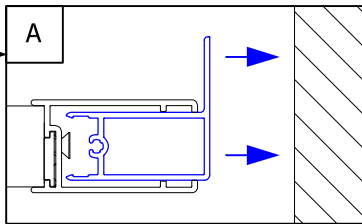
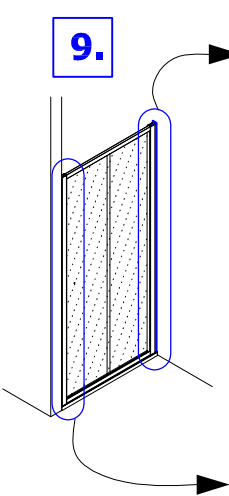

10.

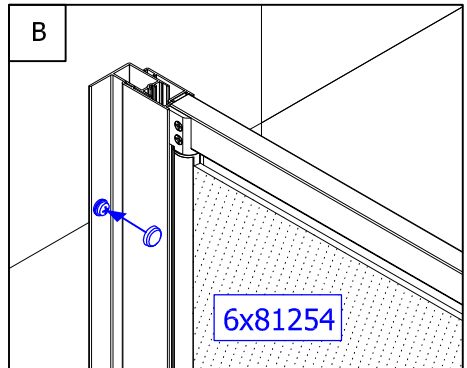
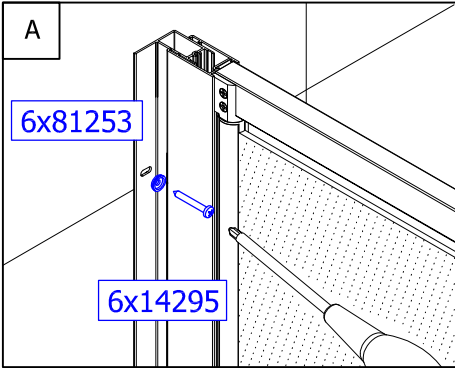
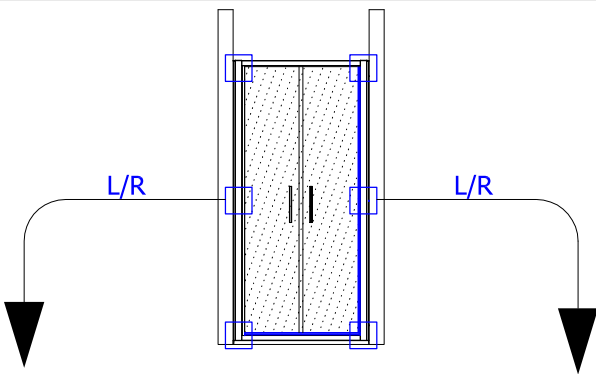

11.

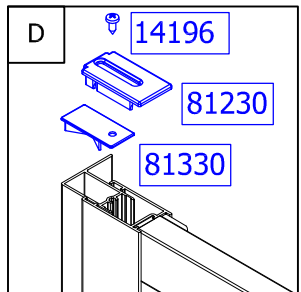
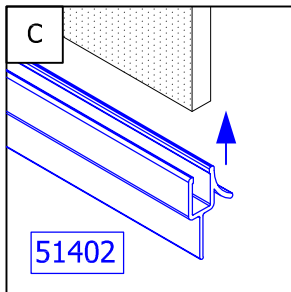
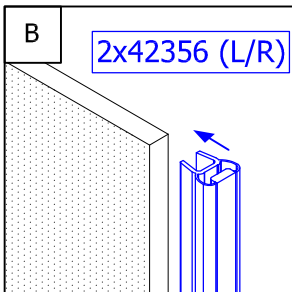
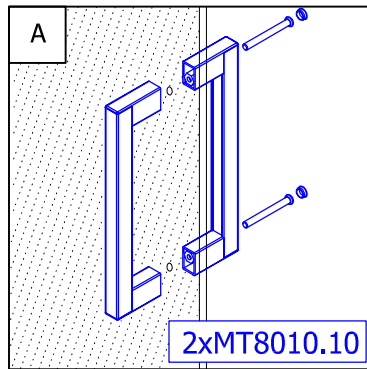
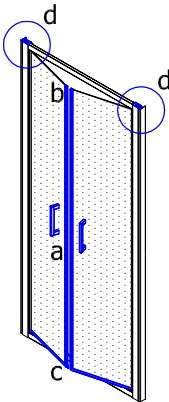

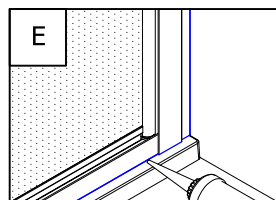
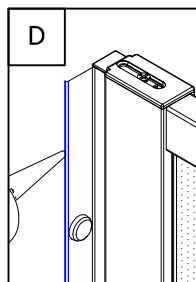
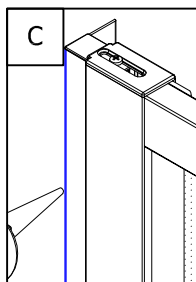
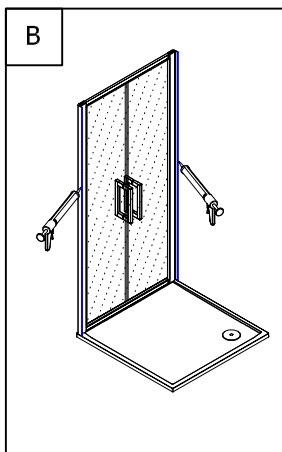
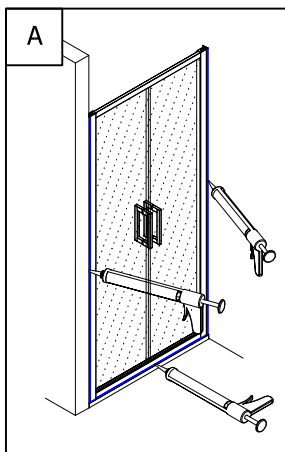

Achtung! Nur Sanitär-Silikon - bakterizid und fungizid eingestellt verwenden.

Caution! Use only bactericidal and fungicidal sanitary silicone.

Attention! N'utiliser que du silicone sanitaire bactéricide et fongicide.

Pozor! Používejte pouze baktericidní a fungicidní sanitární silikon.

Uwaga! Stosować tylko silikon sanitarny - bakterio i grzybobójczy.

Pozor! Užívajte pouze baktericidný a fungicidný sanitárny silikon.

Внимание! Применяйте только антибактериальные силиконовые герметики с фунгицидом

Cuidado! Utilizar solamente silicona sanitaria bactericida y fungicida.

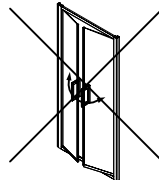
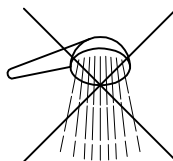

12.

DETAIL A - MT8010

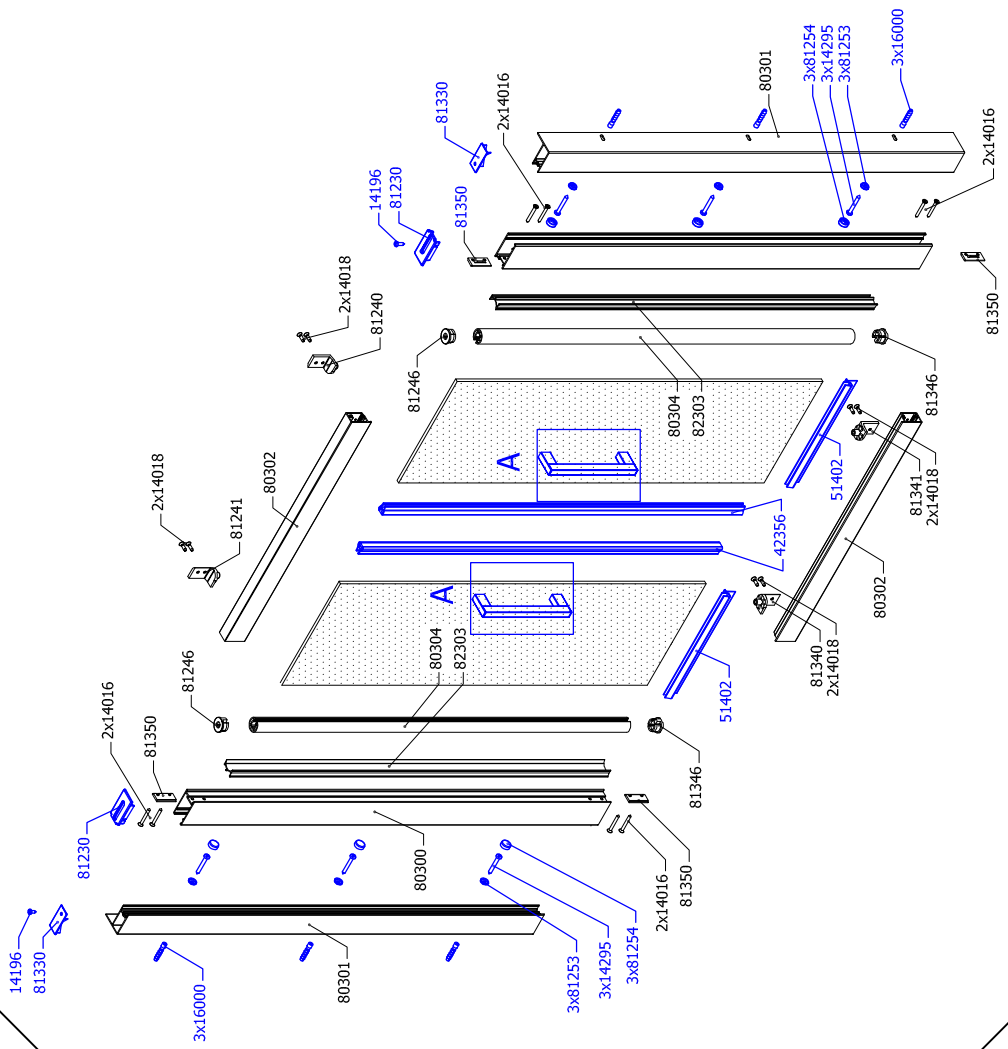
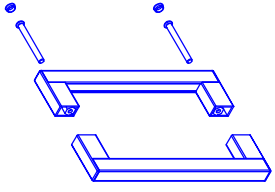

QUALITY CONTROL:

- D** Dieses Produkt wurde unter sorgfältiger Beachtung der Qualitäts-Richtlinien gefertigt und vor dem Verpacken einer eingehenden Prüfung unterzogen. Sollten Sie dennoch einen Produktmangel oder eine Beschädigung feststellen, so setzen Sie sich bitte direkt mit der Firma in Verbindung, bei der Sie dieses Produkt gekauft haben.
- GB** This product was made with careful attention to quality guidelines and was subjected to a thorough examination before packaging. However, if you find a product defect or damage so please get in touch directly with the company in which you have bought this product.
- F** Ce produit est fabriqué avec une attention particulière selon des normes de qualité et est soumis à un contrôle approfondi avant l'emballage. Toutefois, si le produit présente un défaut ou un dommage, veuillez prendre contact avec l'entreprise qui vous a vendu ce produit.
- CZ** Tento produkt byl vyroben s odbornou péčí podle příslušných kvalitativních směrnic a před zabalením byl důkladně zkontrolován. Pokud u něho přesto zjistíte závadu nebo poškození, kontaktujte prosím firmu, u které jste výrobek zakoupili.
- PL** Produkt ten został wyprodukowany z uwzględnieniem rygorystycznych norm jakościowych, a następnie podany drobiazgowej kontroli przed zapakowaniem. Jeżeli po rozpakowaniu (przed rozpoczęciem montażu!) stwierdzicie Państwo wady lub uszkodzenia to prosimy o natychmiastowe zgłoszenie tego faktu sprzedawcy.
- SK** Tento produkt bol vyrobený s odbornou starostlivosťou podľa príslušných kvalitatívnych smerníc a pred zabalením bol dôkladne skontrolovaný. Ak u neho aj napriek tomu zistíte závalu alebo poškodenie, kontaktujte prosím firmu, u ktorej ste výrobok zakúpili.
- RU** Это изделие было изготовлено с особым вниманием в соответствии с высокими стандартами качества и было тщательно проверено перед упаковкой. В то же время, если вы обнаружите дефект или повреждение, обратитесь в компанию, у которой вы купили это изделие.
- E** Este producto ha sido fabricado cumpliendo estrictamente las normativas de calidad y ha sido sometido a un control exhaustivo antes de embalarlo. En caso de que a pesar de ello, Usted note algún desperfecto del producto, rogamos se ponga en contacto directamente con la empresa donde haya comprado el producto.
- RO** Acest produs a fost fabricat respectând cele mai stricte norme de calitate, iar produsul a fost testat înainte de a fi împachetat. Dacă totuși observați o neregulă sau o defecțiune, vă rugăm să contactați direct firma de la care ați achiziționat produsul.

.....

.....

.....

.....

.....

.....

